



Prep and Load Platform

Accessories

HPLC



PAL-*xt* product line
accessory catalogue 2013

Syringe Kits	3
Syringes	4
Syringe Plungers	5
Trays and Traysets	5 - 6
Thermostatted Trayholders	6 - 7
Stacks and Thermostatted Stacks	7 - 8
Valve Drives and Injection Valves	8 - 14
Maldi Option	14
Solvent Reservoir	14
PAL Dilutor and Consumables	15
DLW-2	16
Fast Wash Station	17
Flow Cell	17
xt- Upgrade Kits	18
Software	18
Barcode Reader	19
Microplate Foil Cutter and Tools	19
IQ/OQ Protocols and Tools	19

Important notice:

If not specifically mentioned all options and accessories are also available for previous PAL HTC / HTS systems.

PALBrochCat2013

CTC Analytics does not supply sample vials, caps and seals for PAL Systems. CTC refers to the following companies, who distribute certified and approved PAL consumables. The local distributors can be found on the corresponding websites.

Worldwide

La-Pha-Pack® GmbH

Am Parir 20
D-52379 Langerwehe
Germany

Tel: +49 24239431-0
Fax: +49 24239431-33
Email: service@la-pha-pack.com
Web: www.la-pha-pack.com

Chromacol Ltd

3 Mundells Industrial Centre
Welwyn Garden City
Herts, AL7 1EW,
United Kingdom

Tel: +44 1707 394949
Fax: +44 1707 391311
Email: enquiries@chromacol.com
Web: www.chromacol.com

North America only

Microliter Analytical Supplies

P.O. Box 808
3680 Burnette Park Dr. Suite# C
Suwanee, GA 30024
USA

Tel: 1-888-232-7840
Fax: 770-932-6652
Email: microliter@aol.com
Web: www.microliter.com

CTC Analytics

Where design meets performance

CTC Analytics AG
Switzerland
info@ctc.ch
www.palsystem.com

PAL Accessory	Part Number	Description	HTS-xt	HTC-xt
Syringe Kits 	PAL SyrLCX25µl	Kit LC X -Syringe 25µl* 1 pc syringe adapter and 1pc plunger holder 2 pcs syringe SYRX G25-22S-3	•	•
	PAL SyrLCX50µl	Kit LC X -Syringe 50µl* 1 pc syringe adapter and 1pc plunger holder 2 pcs syringe SYRX G50-22S-3	•	•
	PAL SyrLCX100µl	Kit LC X -Syringe 100µl* 1 pc syringe adapter and 1pc plunger holder 2 pcs syringe SYRX G100-22S-3	•	•
	PAL SyrLCX100µl-22	Kit LC X -Syringe 100µl* 1 pc syringe adapter and 1pc plunger holder 2 pcs syringe SYRX G100-22-3	•	•

*Special inert syringe for high throughput and **X**-tra low carry-over applications

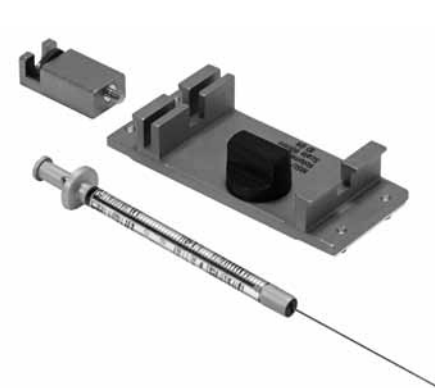

PAL SyrLC10µl	Kit LC Syringe 10µl 1 pc syringe adapter and plunger holder 2 pcs syringe SYRC G10-22S-3	•	•
PAL SyrLC25µl	Kit LC Syringe 25µl 1 pc syringe adapter and plunger holder 2 pcs syringe SYRC G25-22S-3	•	•
PAL SyrLC100µl	Kit LC Syringe 100µl 1 pc syringe adapter and plunger holder 2 pcs syringe SYRC G100-22S-3	•	•
PAL SyrLC250µl	Kit LC Syringe 250µl 1 pc syringe adapter and plunger holder 2 pcs syringe SYRC G250-22-3	•	•
PAL SyrLC500µl	Kit LC Syringe 500µl 1 pc syringe adapter and plunger holder 2 pcs syringe SYRC G500-22-3	•	•
PAL SyrLC1000µl	Kit LC Syringe 1000µl 1 pc syringe adapter and plunger holder 2 pcs syringe SYRC G1000-22-3	•	•
PAL SyrLC2500µl	Kit LC Syringe 2500µl 1 pc syringe adapter and plunger holder 2 pcs syringe SYRC G2500-22-3	•	•
PAL SyrLC5000µl	Kit LC Syringe 5000µl 1 pc syringe adapter and plunger holder 2 pcs syringe SYRC G5000-22-3	•	•

PAL Accessory	Part Number	Description	HTS-xt	HTC-xt
X-Type Syringes 	SYRX G25-22S-3	Syringe X -type gastight 25µl* fixed needle, gauge 22S,pointstyle 3	•	•
	SYRX G50-22S-3	Syringe X -type gastight 50µl* fixed needle, gauge 22S,pointstyle 3	•	•
	SYRX G100-22-3	Syringe X -type gastight 100µl* fixed needle, gauge 22, pointstyle 3 (fast aspiration and eject speed)	•	•
	SYRX G100-22S-3	Syringe X -type gastight 100µl* fixed needle, gauge 22S,pointstyle 3 (low dead volume)	•	•
*Special inert syringe for high throughput and X -tra low carry-over applications				

C-Line Syringes





SYRC G10-22S-3	Syringe gastight 10µl Fixed needle, gauge 22S, pointstyle 3	•	•
SYRC G25-22S-3	Syringe gastight 25µl Fixed needle, gauge 22S, pointstyle 3	•	•
SYRC G100-22-3	Syringe gastight 100µl Fixed needle, gauge 22, pointstyle 3 (fast aspiration and eject speed)	•	•
SYRC G100-22S-3	Syringe gastight 100µl Fixed needle, gauge 22S, pointstyle 3 (low dead volume)	•	•
SYRC G250-22-3	Syringe gastight 250µl Fixed needle, gauge 22, pointstyle 3	•	•
SYRC G500-22-3	Syringe gastight 500µl Fixed needle, gauge 22, pointstyle 3	•	•
SYRC G1000-22-3	Syringe gastight 1000µl Fixed needle, gauge 22, pointstyle 3	•	•
SYRC G2500-22-3	Syringe gastight 2500µl Fixed needle, gauge 22, pointstyle 3	•	•
SYRC G5000-22-3	Syringe gastight 5000µl Fixed needle, gauge 22, pointstyle 3	•	•

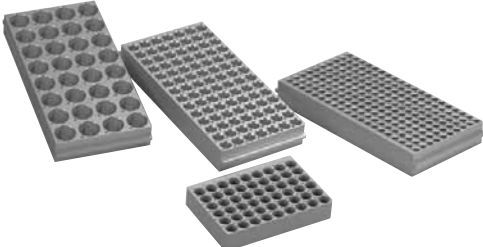

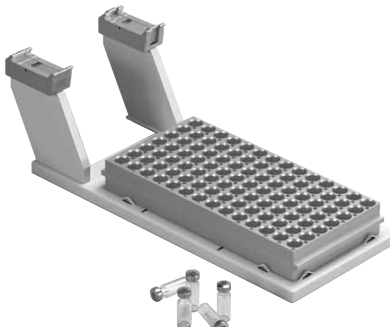
PAL Accessory	Part Number	Description	HTS-xf	HTC-xf
Replacement Plungers 	PLG X25	3 pcs replacement plunger for SYRX G25 syringe	●	●
	PLG X50	3 pcs replacement plunger for SYRX G50 syringe	●	●
	PLG X100	3 pcs replacement plunger for SYRX G100 syringe	●	●
	PLG G10	10 pcs replacement plunger for 10µl syringe	●	●
	PLG G25	10 pcs replacement plunger for 25µl syringe	●	●
	PLG G100	10 pcs replacement plunger for 100µl syringe	●	●
	PLG G250	10 pcs replacement plunger for 250µl syringe	●	●
	PLG G500	10 pcs replacement plunger for 500µl syringe	●	●
	PLG G1000-L	1 pc replacement plunger for 1000µl syringe	●	●
	PLG G2500	1 pc replacement plunger for 2500µl syringe	●	●
	PLG G5000	1 pc replacement plunger for 5000µl syringe	●	●

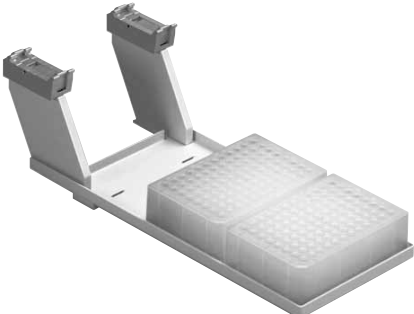
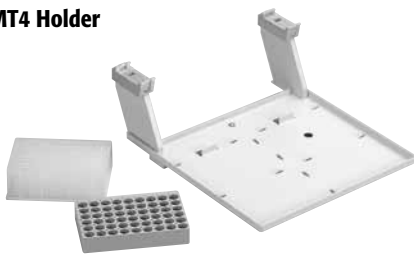
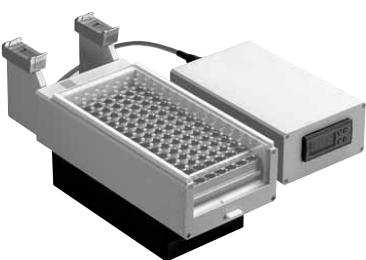
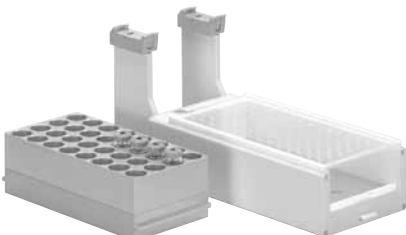
Trays 	PAL Tray1ml	Sample tray for 200 vials 0.7/1ml	●	●
	PAL Tray2ml	Sample tray for 98 vials 2ml or 78 vials 0.7/1ml	●	●
	PAL Tray20ml	Sample tray for 32 vials 10/20ml or 21 vials 2ml	●	●
	PAL TrayMT2ml	Sample tray for PAL Stack6DW or LC PAL Trayholder 54 x 2ml vials 6 Trays for 1 PAL Stack6DW 4 Trays for 1 LC PAL Trayholder	●	●
	PAL TrayMT2ml/6	Set of 6 pcs PAL TrayMT2ml sample trays	●	●
	PAL TrayMT10ml/6	Set of 6 pcs PAL TrayMT15ml sample trays	●	●

Traysets 	PAL TraySet1ml	Sample tray for 200 vials 0.7/1ml, including trayholder 76mm	●	●
	PAL TraySet2ml	Sample tray for 98 vials 2ml or 78 vials 0.7/1ml, including trayholder 76mm	●	●
	PAL TraySet2ml-2	Sample tray for 98 vials 2ml or 78 vials 0.7/1ml, including trayholder 114mm (holder may be alternatively used for 20ml vial trays)	●	●

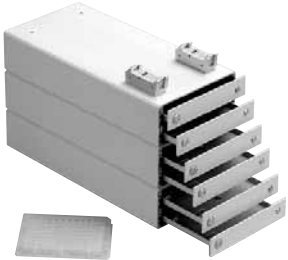
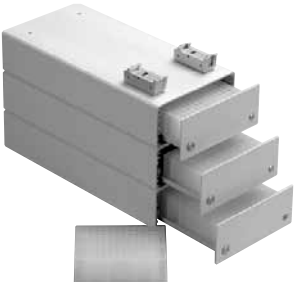
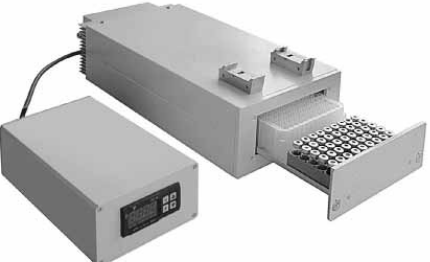
PAL Accessory	Part Number	Description	HTS-xt	HTC-xt
Trayset MT 	PAL MTHolder	Trayholder 76mm for 2 microtiter/deepwell plates (96/384 wells) or 2 PAL TrayMT2ml	•	•
MT4 Holder 	PAL MT4Holder	Trayholder 76mm for 4 microtiter/deepwell plates (96/384 wells) or 4 PAL TrayMT2ml	•	•
Tray Cooler (Peltier Version) 	PAL TrayCooler- xt	Peltier Cooler 4°C to 70°C* for 1 PAL Tray2ml or 1 PAL Tray1ml or 1 microtiter- or deepwell plate (96 wells) consisting of: 1 pc Tray Cooler with 84mm legs 1 pc plastic tray cover for PAL Tray2ml 1 pc power supply 110V/240V LED display, temperature regulation ± 1°C (* sample tray not included)	•	•
	MC 30-10	Plastic tray cover for PAL Tray1ml	•	•
	MC 30-11	Plastic tray cover for PAL Tray2ml	•	•
	MC 30-14	Plastic tray cover for 96 well MT/DW	•	•
	MC 50-01	Adapter plate for 96 well MT/DW	•	•
Tray Cooler 2 (Liquid Version) 	PAL LiqCooler2	Liquid Tray Cooler 4°C to 70°C* consisting of: 1 pc Liquid TrayCooler with 136mm legs 1 pc cooling plate for 32 20ml vials 1 pc plastic tray cover for PAL Tray2ml (* excluding external circulator)	•	•
	MP 50-031	Cooling plate for 32 20ml vials (requires PAL LiqCooler2)	•	•

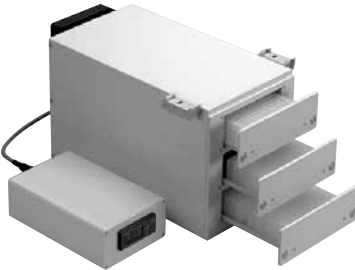
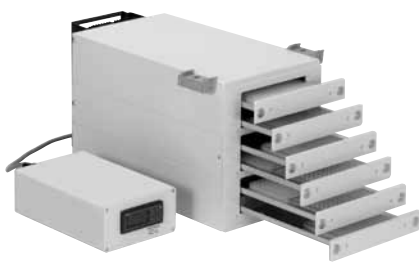
PAL Accessory	Part Number	Description	HTS- <i>xt</i>	HTC- <i>xt</i>
Tray Cooler (Liquid Version) 	PAL LiqCooler	Liquid Tray Cooler 4°C to 70°C* for 1 PAL Tray2ml or 1 PAL Tray1ml or 1 microtiter- or deepwell plate (96 wells) including 1 plastic tray cover for PAL Tray2ml (*excluding Sample Tray and external circulator)	•	•
	MC 30-10	Plastic tray cover for PAL Tray1ml	•	•
	MC 30-11	Plastic tray cover for PAL Tray2ml	•	•
	MC 30-14 MC 50-01	Plastic tray cover for 96 well MT/DW Adapter plate for 96 well MT/DW	• •	• •
Stack for standard microplates 	PAL Stack12MT	PAL System stack for 12 microtiter plates (96/384 wells)	•	•
Stack for deepwell plates 	PAL Stack6DW	PAL System stack for 6 microtiter plates (96/384 wells) or 6 deepwell plates (96/384 wells) or 6 PAL TrayMT2ml	•	•
Stack Cooler 2DW (Peltier Version) 	PAL StkCooler2 DW- <i>xt</i>	Peltier cooled 2DW Stack 4°C to 40°C for 2 deepwell- or microplates (96/384 wells) or 2 PAL TrayMT2ml including 1pc power supply 110V/240V LED display, temperature regulation ± 1°C	•	•

PAL Accessory	Part Number	Description	HTS-xt	HTC-xt
<p>Stack Cooler (Peltier Version)</p> 	PAL StkCooler-xt	Peltier cooled 6DW Stack 4°C to 40°C for 6 deepwell- or microtiter plates (96/384) or 6 PAL TrayMT2ml including power supply 110V/240V LED display, temperature regulation ± 1°C	•	•
<p>Stack Cooler MT (Peltier Version)</p> 	PAL StkCooler 12MT-xt	Peltier cooled 12MT Stack 4°C to 40°C for 12 microtiter plates (96/384 wells) including power supply 110V/240V LED display, temperature regulation ± 1°C	•	•
<p>LC Injection Valve, type Rheodyne</p> 	PD7991-K	6-port Rheodyne Injection Valve, 0.2mm bore pressure up to 1000bar (15'000psi) incl. needle guide, needle seal, kit LCVlvR (requires valve drive PAL VlvDrvR)	•	•
	PD718-313-K	6- port Rheodyne Injection Valve 0.2mm bore pressure up to 1200 bar (17'500psi) incl. needle guide, needle seal, kit LCVlvR mounted 2µl loop and VHP-200 fittings (requires valve drive PAL VlvDrvR-32)	•	•
	PD718-315-K	6- port Rheodyne Injection Valve 0.2mm bore and MBB Coated, stainless steel rotor seal (RPC-13) Pressure up to 1200 bar, incl. needle guide, needle seal, Kit LCVlvR, (requires PAL VlvDrvR-32).	•	•



PAL Accessory	Part Number	Description	HTS-xf	HTC-xf
Valve Accessories, type Rheodyne 	TR050306B	Sample loop 5µl Stainless Steel	●	●
	TR050306C	Sample loop 10µl Stainless Steel	●	●
	TR050306D	Sample loop 20µl Stainless Steel	●	●
	TR050306E	Sample loop 50µl Stainless Steel	●	●
	TR050306F	Sample loop 100µl Stainless Steel	●	●
	9055-021	Sample loop 10µl PEEK	●	●
	9055-022	Sample loop 20µl PEEK	●	●
	PD718SL2	Sample loop, 2µl for Rheodyne PD718-313 and PD718-315	●	●
	PD718SL10	Sample loop, 10µl for Rheodyne PD718-313 and PD718-315	●	●
	PD718SL20	Sample loop, 20µl for Rheodyne PD718-313 and PD718-315	●	●
	PD718SL100	Sample loop, 100ul for Rheodyne PD 718-313 and PD718-315	●	●
	PD718-SPC3	Stator for PD718-313	●	●
	PD718-RPC13-6	Rotor for PD718-313	●	●
	PD718-315-SPC3	Stator for PD718-315	●	●
PD718-315 RPC	Rotor for PD718-315	●	●	
PAL NdISealR	10 pcs needle seal, gauge 22	●	●	



LC Injection Valve, type Cheminert

	C2V-0006D-CTC-K	6-port Cheminert Injection Valve 0.15mm bore incl. needle guide, needle seal, kit LCVlv	●	●
	C2V-0346D-CTC-K	6-port Cheminert Injection Valve PAEK 0.15mm bore incl. needle guide, needle seal, kit LCVlv	●	●
	C2V-1006D-CTC-K	6-port Cheminert Injection Valve 0.25mm bore incl. needle guide, needle seal, kit LCVlv	●	●
	C2V-1346D-CTC-K	6-port Cheminert Injection Valve PAEK 0.25mm bore incl. needle guide, needle seal, kit LCVlv	●	●
	C2V-3006D-CTC-K	6-Port Cheminert Injection Valve 0.75mm bore (prep version) incl. needle guide, needle seal, kit LCVlv	●	●
	C2VH-1000D-CTC-K	10-port Cheminert Injection Valve 0.25mm bore incl. needle guide, needle seal, kit LCVlv	●	●
	C5F-1004D-CTC	8-port VICI Selector Valve 0.25mm bore (requires PAL SelVlv)	●	●
	C72VX-1676D-CTC-K	6-port Cheminert Injection Valve, 0.25mm bore pressure up to 1000bar (15'000psi) incl. needle guide, needle seal, kit LCVlv	●	●
	C72VX-1670D-CTC-K	10-port Cheminert Injection Valve, 0.25mm bore pressure up to 1000bar, (15'000psi) incl. needle guide, needle seal, kit LCVlv (requires PAL 1VlvDrv-D high torque valve drive)	●	●
	C72VU-6676-D-CTC-K	6- port injection valve Cheminert, 0.15mm bore pressure up to 1275bar (18'500psi) incl. 2µl and 20µl loop. 20µl loop already mounted. incl. needle guide, needle seal, kit LCVlv	●	●

If not otherwise mentioned
all valves require the following valve drive: PAL VlvDrv

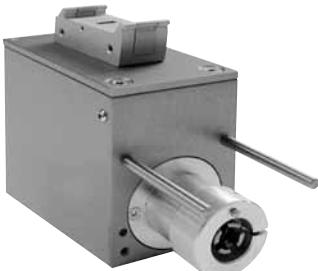
PAL Accessory	Part Number	Description	HTS-xt	HTC-xt
Valve Accessories, type Cheminert 	CSL5K	Sample loop 5000 μ l	•	•
	CSL2K	Sample loop 2000 μ l	•	•
	CSL1K	Sample loop 1000 μ l	•	•
	CSL500	Sample loop 500 μ l	•	•
	CSL250	Sample loop 250 μ l	•	•
	CSL100	Sample loop 100 μ l	•	•
	CSL50	Sample loop 50 μ l	•	•
	CSL20-CTC	Sample loop 20 μ l	•	•
	CSL10-CTC	Sample loop 10 μ l	•	•
	CSL5-CTC	Sample loop 5 μ l	•	•
	CSL2-CTC	Sample loop 2 μ l	•	•
	CZSL20PK	Sample loop PEEK 20 μ l	•	•
	CZSL10PK	Sample loop PEEK 10 μ l	•	•
	CZSL5PK	Sample loop PEEK 5 μ l	•	•
	CZSL2PK	Sample loop PEEK 2 μ l	•	•
	PAL NdISealP	10 pcs PEEK needle seal, gauge 22	•	•
	PAL NdISeal	10 pcs needle seal, gauge 22	•	•
	PAL NdISeal-19	10 pcs needle seal, gauge 19	•	•
	C2-00R6	Rotor for C2V + C2-0006D-CTC-K	•	•
	C2V-0C06	Stator for C2V-0006D-CTC-K	•	•
C2-03R6	Rotor for C2V + C2-0346D-CTC-K	•	•	
C2V-0C46	Stator for C2V-0346D-CTC-K	•	•	
C2-10R6	Rotor for C2V-1006D-CTC-K	•	•	
C2V-1C06	Stator for C2V-1006D-CTC-K	•	•	
C2-13R6	Rotor for C2V-1346D-CTC-K	•	•	
C2V-1C46	Stator for C2V-1346D-CTC-K	•	•	
C2-30R6	Rotor for C2V-3006D-CTC K, Valcon-H	•	•	
C2V-3C06	Stator for C2V-3006D-CTC-K	•	•	
C2-10R0H	Rotor for C2VH-1000D-CTC-K	•	•	
C2V-1C00H	Stator for C2VH-1000D-CTC-K	•	•	
C5F-10R4	Rotor for C5F-1024D-CTC/C5F-1004D-CTC-K	•	•	
C5-1C28	Stator for C5F-1004D-CTC-K	•	•	
C72-16R6	Rotor for C72VX-1696D-CTC-K and C72VX-1676D-CTC-K	•	•	
C72V-1C76	Stator for C72VX-1676D-CTC-K	•	•	
C72-16R0	Rotor for C72VX-1690D-CTC-K and C72VX-1670D-CTC-K	•	•	
C72V-1C70	Stator for C72VX-1670D-CTC-K	•	•	
C72-66R6	Rotor for C72VU-6676D-CTC / C72VX-6690D-CTC/ C72VU6096D-CTC	•	•	
C72V-6C76	Stator for C72VU-6676D-CTC	•	•	

PAL Accessory	Part Number	Description	HTS-xf	HTC-xf
LC Injection Valves, type WK 	DC10WK-CTC-K	10-port VICI type WK Injection Valve 0.4mm bore, incl. needle guide, needle seal, kit LCVlv	•	•
	DC6WK-CTC-K	6-port VICI type WK Injection Valve 0.4mm bore, incl. needle guide, needle seal, kit LCVlv	•	•
	DCI4WK.5/1-CTC-K	4-port VICI type WK Injection Valve 0.4mm bore, internal loop 0.5/1.0µl incl. needle guide, needle seal, kit LCVlv	•	•
	<hr/>			
Valve Accessories, type WK 	SL1KCW	Sample loop 1000µl	•	•
	SL500CW	Sample loop 500µl		
	SL250CW	Sample loop 250µl		
	SL200CW	Sample loop 200µl		
	SL100CW	Sample loop 100µl		
	SL50CW	Sample loop 50µl		
SL20CW	Sample loop 20µl			
	PAL NdISeal	10 pcs needle seal, gauge 22, VICI valve type WK or Cheminert	•	•
	SSACI4W.5/1	Rotor for DCI4WK.5/1-CTC-K, internal loop 0.5/1µl	•	•
	SSAC6W	Rotor for DC6WK-CTC-K	•	•
	SSAC10W	Rotor for DC10WK-CTC-K	•	•
<hr/>				
2-Position Injection Valve Drive (AUX) 	PAL VlvDrv	PAL Valve drive for Valco LC valve type WK or C (without valve), consisting of: 1 pc valve drive 1 set connection cable	•	•
	PAL VlvDrvR-32	PAL Valve drive for Rheodyne valve PD718 series (without valve), consisting of: 1 pc valve drive 1 set connection cable	•	•
	PAL VlvDrvR	PAL Valve drive for Rheodyne valve PD7991-K (without valve), consisting of: 1 pc valve drive 1 set connection cable	•	•

PAL Accessory	Part Number	Description	HTS-xt	HTC-xt
4 Fold Injection Valve Module 	PAL 4VlvDrv	PAL 4-Valve Module, type 2 consisting of: 4 pcs valve drives 1 pc PEEK solvent manifold 1 set PEEK tubing kit including PEEK fittings 1 set connection cable (requires VICI Valco Valves, type DCxWK, type C and sample loops)	•	•
	PAL MuxKit	Kit for Waters MUX™ interface consisting of: 4 pcs check valve for waste port	•	•
	CV-3345	1 pc check valve for MUX Kit	•	•
PAL Selector Valve 	PAL SelVlv	8-port Selector valve, type 2 consisting of: 1 pc 8-port Selector valve C5F 1 pc 2 meter PTFE tubing waste lines 1 pc valve drive 1 set connection cable to PAL 4VlvDrv (requires PAL 4VlvDrv)	•	•
	C5-1C28	Stator for PAL SelVlv C5 Selector Valve	•	•
	C5F-10R4	Rotor for PAL SelVlv C5 Selector Valve	•	•
Valve Drive High Torque 	PAL 1VlvDrv-D	PAL 1-Valve Drive Module consisting of: 1 pc High torque multiposition valve drive 1 set connection cable (requires VICI Valco LC Valves, type DCxWK-K or type C)	•	•

PAL Accessory	Part Number	Description	HTS-xf	HTC-xf
---------------	-------------	-------------	--------	--------

Multiposition Valve Drive Module

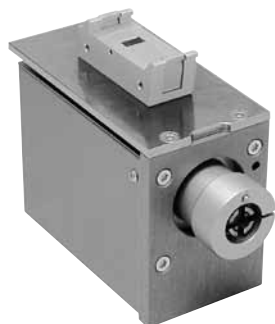

PAL 1VlvDrv

PAL 1-Valve Drive Module consisting of:
 1 pc multiposition valve drive with bracket
 1 set connection cable
 (requires VICI Valco LC Valves, type DCxWK-K or type C)

•

•

Dual Valve Drive Module



PAL 2VlvDrv

PAL 2-Valve Drive Module consisting of:
 2 pcs multiposition valve drives with bracket
 1 set connection cable
 (requires VICI Valco LC Valves, type DCxWK-K or type C)

•

•

Triple Valve Drive Module

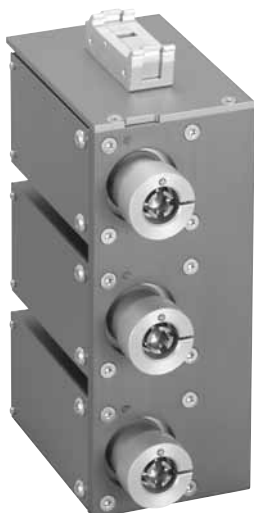

PAL 3VlvDrv

PAL 3-Valve Drive Module consisting of:
 3 pcs multiposition valve drives with bracket
 1 set connection cable
 (requires VICI Valco LC Valves, type DCxWK-K or type C)

•

•

PAL Accessory	Part Number	Description	HTS-xt	HTC-xt
---------------	-------------	-------------	--------	--------

Column Switching Valve Module

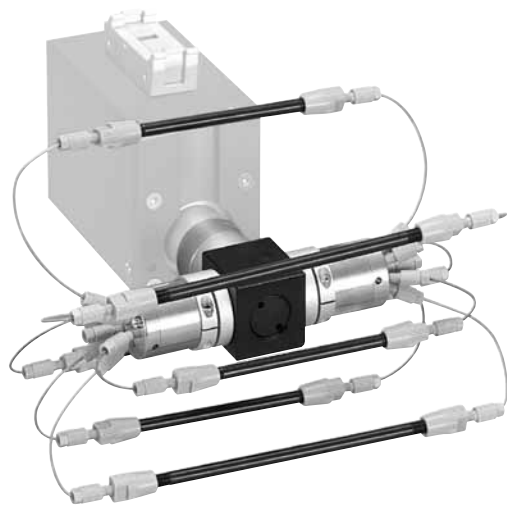

PAL ColSel6

Column Switching Valve Module for up to 6 columns consisting of:
 2 pcs 6-port Column Selector Valve 0.25mm bore (requires Cycle Composer or PAL ICC-CE Software and PAL 1VlvDrv)

• •

MALDI Option



PAL MALDIOpt

PAL MALDI Option Fraction Collection system consisting of:
 1 pc tool parking bracket
 1 pc MALDI spotting tool
 3 pcs spotting tips
 1 pc tool holder
 1 pc waste tube
 1 pc microfluidic fitting and tubing accessories
 1 pc CD-ROM PAL firmware 3.0 and CycleComposer cycles (requires PAL firmware 3.0 or higher and Cycle Composer)

• •

MP 52-01

MALDI target adapter for 2pcs. Waters 96/384 Targets

• •

MP 52-02

MALDI target adapter for 2pcs. ABI Opti-TOF or

• •

2 pcs ABI 4700 / Voyager

MP 52-04

MALDI target adapter for 1pc Bruker AnChor Chip

• •

MSPoTip3

3 pcs coated fused silica spotting tips, 360µm OD, 20µm ID

• •

Solvent Reservoir



PAL 3xSolv100

Solvent Reservoir consisting of:
 1 pc holder for 3pcs 100ml vials
 3 pcs solvent vials 100ml including caps and seals

• •

100-WV

100ml solvent bottle for PAL Wash Station, PAL WashLarge or PAL 3xSolv100 Solvent Reservoir including cap and seal

• •

Kit SealCap

10 caps and 10 seals for 100-WV solvent bottle or PAL waste port

• •

PAL HPLC Accessories

PAL Accessory	Part Number	Description	HTS-xf	HTC-xf
Dilutor Set 	PAL Dilutor	PAL Dilutor Option consisting of: 1 pc Dilutor module 1 pc Dilutor syringe 2.5ml 1 pc solvent bottle transfer line including solvent filter 1 pc solvent bottle 1000ml with cap 1 pc transfer tubing kit 1/16" 1 pc Dilutor module connection cable 1 pc operating manual (requires PAL SyrLCSP80µl or PAL SyrLCSP20µl)	●	●
	PAL SyrLCSP80µl	Kit Dilutor Syringe 80µl for PAL HTS consisting of: 1 pc sideport syringe plunger sealing screw 1 pc sideport syringe adapter 1 pc sideport syringe plunger holder 1 pc sideport syringe 80µl SYRC SP80-R 3 pcs Ndl S-22-3 needles gauge 22	●	●
	PAL SyrLCSP20µl	Kit Dilutor Syringe 20µl for PAL HTS consisting of: 1 pc sideport syringe plunger sealing screw 1 pc sideport syringe adapter 1 pc sideport syringe plunger holder 1 pc sideport syringe 20µl SYRC SP20-R 3 pcs Ndl S-22S-3 needles gauge 22S	●	●

Dilutor Syringes and Plungers



SYRC DIL1.0	PAL Dilutor Syringe 1ml	●	●
SYRC DIL2.5	PAL Dilutor Syringe 2.5ml	●	●
SYRC DIL5.0	PAL Dilutor Syringe 5ml	●	●
SYRC DIL10	PAL Dilutor Syringe 10ml	●	●
SYRC SP80-R	Sideport syringe 80µl gastight without needle	●	●
SYRC SP20-R	Sideport syringe 20µl gastight without needle	●	●
Ndl S-22-3	3 pcs replacement needle gauge 22 pointstyle 3 for sideport syringe 80µl	●	●
Ndl S-22S-3	3 pcs replacement needle gauge 22S pointstyle 3 for sideport syringe 20µl	●	●
PLG SP80	10 pcs replacement syringe plunger for 80µl sideport syringe	●	●
PLG SP20	10 pcs replacement syringe plunger for 20µl sideport syringe	●	●
1000-SV	1 pc Dilutor solvent bottle 1000ml	●	●
PLG DIL 1.0	Replacement plunger for dilutor syringe 1.0ml	●	●
PLG DIL 2.5	Replacement plunger for dilutor syringe 2.5ml	●	●
PLG DIL 5.0	Replacement plunger for dilutor syringe 5.0ml	●	●
PLG DIL 10	Replacement plunger for dilutor syringe 10ml	●	●

PAL Accessory	Part Number	Description	HTS- <i>xt</i>	HTC- <i>xt</i>
---------------	-------------	-------------	----------------	----------------

DLW-2 Dynamic Load & Wash Option

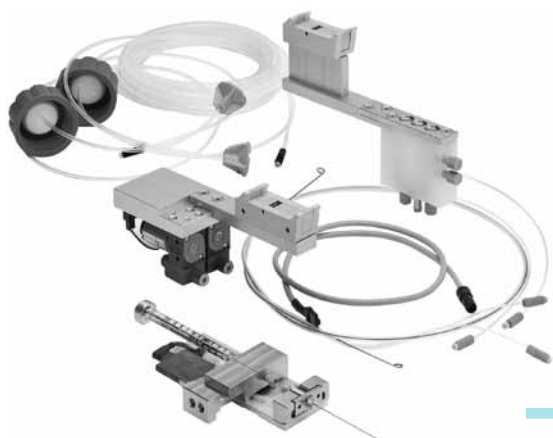

PAL DLW-2 Option	DLW-2 Option for fast and clean LC Cycles	●	●
	1 pc DLW injection adapter with sample holding loop and syringe 100µl		
	1 pc wash Station		
	1 pc wash Solvent pump station with 2 active micro pumps		
	2 pcs 1 liter wash solvent bottles		
	2 pcs solvent bottle transfer line including solvent filter		
	1 pc system CD ROM DLW including Cycles		
	1 pc manual DLW Option		
	requires but does not include xt -Upgrade for PAL and Firmware 4.1.X		

Choose this kit for a PAL-*xt* System

PAL DLW-2-HTS- xt	DLW-2 Option including HTS- xt Upgrade Kit	●	○
	1 pc DLW injection adapter with sample holding loop and syringe 100µl		
	1 pc wash station		
	1 pc wash solvent pump station with 2 active micro pumps		
	2 pcs 1 liter wash solvent bottles		
	2 pcs solvent bottle transfer line including solvent filter		
	1 pc system CD ROM DLW including Cycles		
	1 pc manual DLW Option		
	1 pc kit HTS- xt (control board- xt for PAL System - Firmware 4.1.X)		

Choose this kit if you want to upgrade an existing HTS PAL to the DLW-2 Option

PAL DLW-2-HTC- xt	DLW-2 Option including HTC- xt Upgrade Kit	○	●
	1 pc DLW injection adapter with sample holding loop and syringe 100µl		
	1 pc wash station		
	1 pc wash solvent pump station with 2 active micro pumps		
	2 pcs 1 liter wash solvent bottles		
	2 pcs solvent bottle transfer line including solvent filter		
	1 pc system CD ROM DLW including Cycles		
	1 pc manual DLW Option		
	1 pc kit HTC- xt (control board- xt for PAL System - Firmware 4.1.X)		

Choose this kit if you want to upgrade an existing HTC PAL to the DLW-2 Option

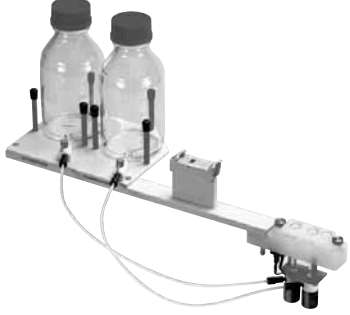
PAL Accessory	Part Number	Description	HTS-xf	HTC-xf
Fast Wash Station 	PAL WashFast-22	Fast Wash Station for PAL HTS two solvents, consisting of: 1 pc double wash station 1 pc holder for 2 x 500ml bottles 1 pc electrical connection cable 1 pc PTFE tubing kit 2 pcs solvent bottles 500ml	●	○
	PAL WashFast3-22	Fast Wash Station for PAL HTC two solvents, consisting of: 1 pc double wash station 1 pc holder for 2 x 500ml bottles 1 pc electrical connection cable 1 pc PTFE tubing kit 2 pcs solvent bottles 500ml	○	●
	PAL TubeFWash	Connection tube incl. fittings and shutoff valve between wash solvent bottle and Fast Wash Station module HTS / HTC PAL (2 pcs PAL TubeFWash are required for 1 Fast Wash Station)	●	●
	PAL TubeWaste	Waste line for PAL Fast Wash Station all types	●	●
	500-WV	500ml wash solvent bottle for PALWashFast-22	●	●
	KitFWash 1000	1000ml solvent kit for PAL WashFast-22	●	●
	1000-WV	1000ml wash solvent bottle for PAL WashFast-22 (requires KitFWash 1000)	●	●

Flow Cell



PAL FlowCell	Flow-Through Cell consisting of: 1 pc Flow-Cell, Stainless Steel type 316 2 pcs Stainless Steel connectors Swagelok 1/4 inch 1 pc holder 88mm 5 pcs inlet Septa, ø10mm	●	●
--------------	--	---	---

PAL Accessory	Part Number	Description	HTS- <i>xt</i>	HTC- <i>xt</i>
---------------	-------------	-------------	----------------	----------------

HPLC -*xt* Upgrade Kits



Kit HTS -*xt*

Kit *xt* Upgrade for HTS PAL Systems

- 1 pc control board-*xt* for PAL System - Firmware 4.X
- 1 pc back cover (for 80cm standard rail version) including screws
- 1 pc MOD BUS Cable (Cbl RS14R-850)
- 1 pc cable for Wash Station (Cbl RS4LX-1300)
- 1 pc aux cable (Cbl RS20R-1300)
- 1 pc LAN cable (3m) (RS81-3000)
- 1 pc system CD ROM for *xt*-Systems
- 1 pc manual *xt*-Upgrade

Choose this kit if you want to upgrade an existing HTS PAL to the -*xt* version

Kit HTC -*xt*

Kit *xt* Upgrade for HTC PAL Systems

- 1 pc control board-*xt* for PAL System - Firmware 4.X
- 1 pc MOD BUS Cable (Cbl RS14R-850)
- 1 pc cable for Wash Station (Cbl RS4LX-700)
- 1 pc aux cable (Cbl RS20R-760)
- 1 pc LAN cable (3m) (Cbl RS81-3000)
- 1 pc system CD ROM for *xt*- Systems
- 1 pc manual *xt*-Upgrade

Choose this kit if you want to upgrade an existing HTS PAL to the -*xt* version

Software and Drivers



PAL CycCompCD

Cycle Composer remote control software for PAL System

CD ROM consisting of:

- 1 Cycle Composer standalone version
- 1 PAL Driver for Agilent ChemStation data system
- 1 PAL Driver for Thermo Xcalibur data system (requires PAL Firmware 2.2.0 or higher and Win 2000/XP or higher)

PAL CycCompCD5

Cycle Composer remote control software for PAL System

CD ROM, site license for 5 instruments consisting of:

- 1 Cycle Composer standalone version including 5 serial numbers
- 1 PAL Driver for Agilent ChemStation data system
- 1 PAL Driver for Thermo Xcalibur data system (requires PAL Firmware 2.2.0 or higher and Win 2000/XP or higher)

PAL CycEdit

PAL Cycle Editor license

PAL ICC-CE

CTC Instrument control components including Cycle Editor



PAL DrvEmp

PAL Driver for Waters Empower2

PAL DrvEmp3

PAL Driver for Waters Empower3

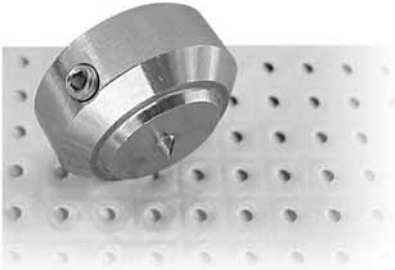
PAL HPLC Accessories

PAL Accessory	Part Number	Description	HTS-xf	HTC-xf
Barcode Reader 	PAL BCReader	Barcode Reader Laser scanner for barcode labels on 2/10/20ml vials including electrical connection cable	•	•
Microtiterplate Foil Cutter 	MSZ 02-01	Microtiterplate foil cutter for needles max. gauge 22	•	•
Toolkit 	PAL Toolkit	Torx driver set for PAL System	•	•
Instrument Qualification 	PAL LC-QDoc	Instrument Qualification for HTS/HTC and LC PAL consisting of: 1 pc Log Book 1 pc Documentation IQ procedure 1 pc Documentation OQ procedure	•	•
	PAL LC-ReQ	Instrument requalification for HTS/HTC and LC PAL consisting of: 1 pc Documentation OQ procedure	•	•